

QSFP28 100G DWDM Dual CS adaptor Transceiver

Product Function

- ◆ Hot pluggable QSFP28 MSA form factor
- ◆ Up to 80km reach for G.652 SMF with transport white box
- ◆ Single +3.3V power supply
- ◆ Temperature Range 0 to 70°C
- ◆ Transmitter: Cooled EML 2*27.5Gbaud/s DWDM TOSA
- ◆ Receiver: 2*27.5Gbaud/s Pin-PD ROSA
- ◆ 4*25G CAUI4 electrical interface
- ◆ Integrated SFEC with high coding gain
- ◆ PAM4 modulation format on 100GHz ITU DWDM wavelength grid compatible
- ◆ Dual CS adaptor
- ◆ Compatible with RoHS6

Transceiver Block Diagram

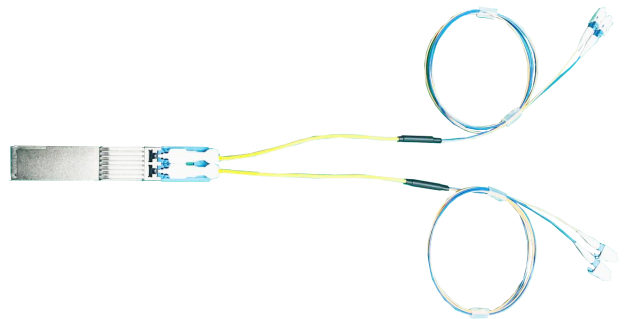
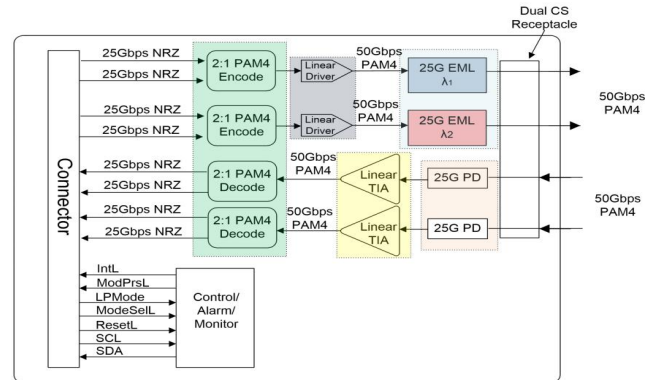



































QSFP28 100G DWDM CS Transceiver

Ordering information

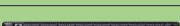
Part No	Specifications						
	Package	Data rate	Tx	Pout	Rx Sen.	Top	Others
RQ-100GD-CXX	QSFP28	103.125 Gbps	Cooled EAM DFB-LD	-1 ~ +4 dBm	-12.5 dBm @BER 4E-3	0~70°C	DDM

Compatibile with main stream DC switch/routers

Switch/Router information		Compatibility test result			
Vendor	Series	Traffic	DDM	Type	Alarm
Cisco	NCS-5501 	Passed 	Passed 	Passed 	Passed 
	N9K-C9316D-GX 	Passed 	Passed 	Passed 	Passed 
	Nexus 3432D-S 	Passed 	Passed 	Passed 	Passed 
Juniper	Juniper MX204 	Passed 	Passed 	Passed 	Passed 
Arista	7060SX2-48YC8 	Passed 	Passed 	Passed 	Passed 
Dell	S5048F-ON 	Passed 	Passed 	Passed 	Passed 
	Z9100-ON 	Passed 	Passed 	Passed 	Passed 

100G QSFP28 DWDM Solution

1. Passive DWDM MUX 1X100G QSFP28 DWDM 120KM Solution

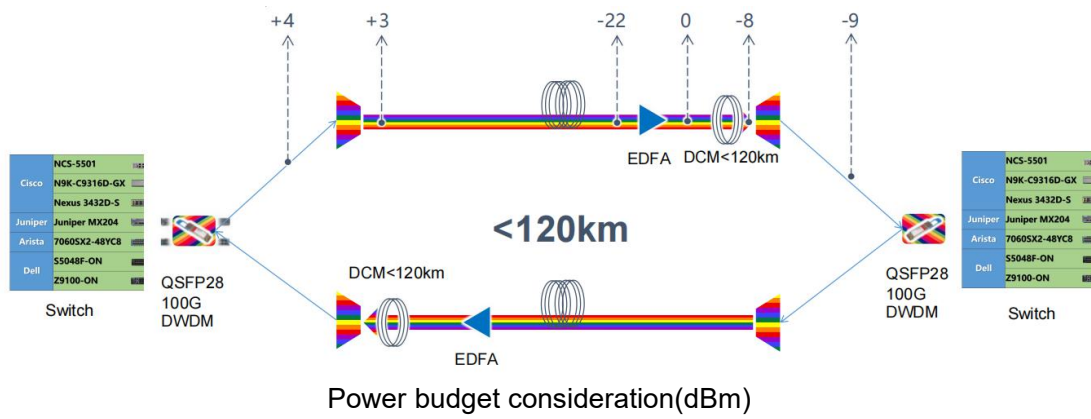

2. Passive DWDM MUX 4X100G QSFP28 DWDM 80KM Solution

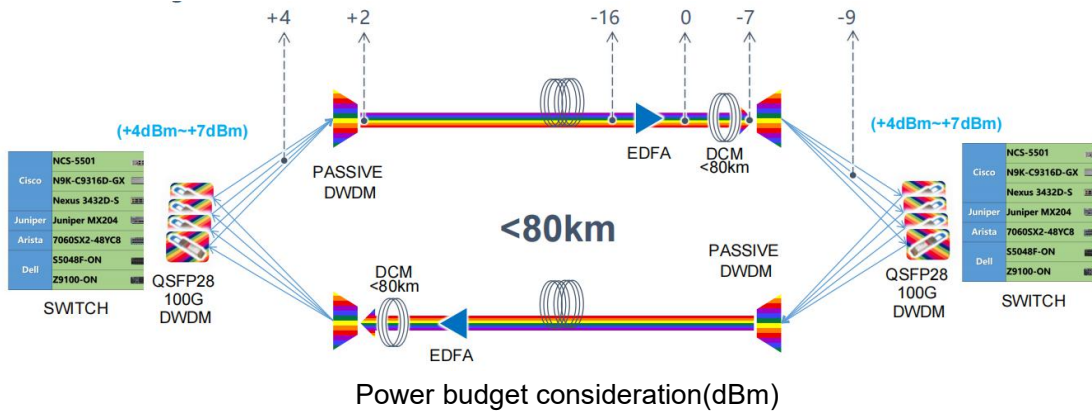

3. Passive DWDM MUX 24X100G QSFP28 DWDM 80KM Solution

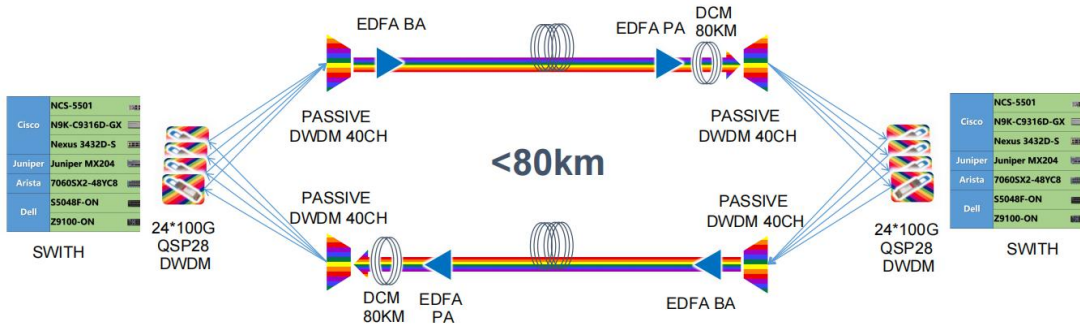

4. Passive DWDM MUX 48X100G QSFP28 DWDM 80KM Solution

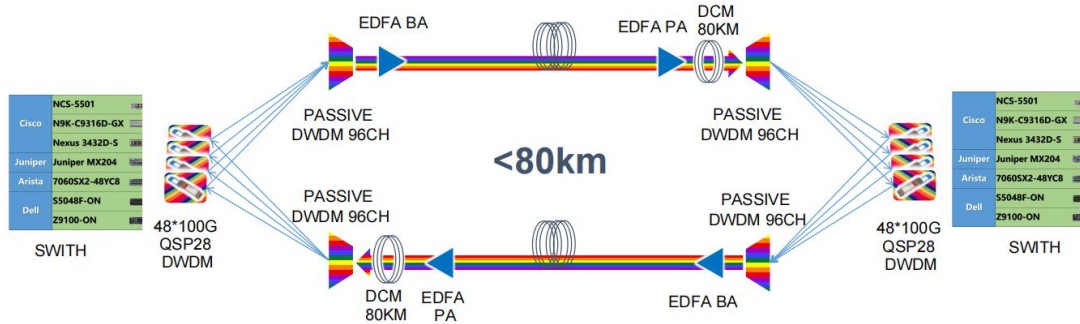

Mechanical Drawings

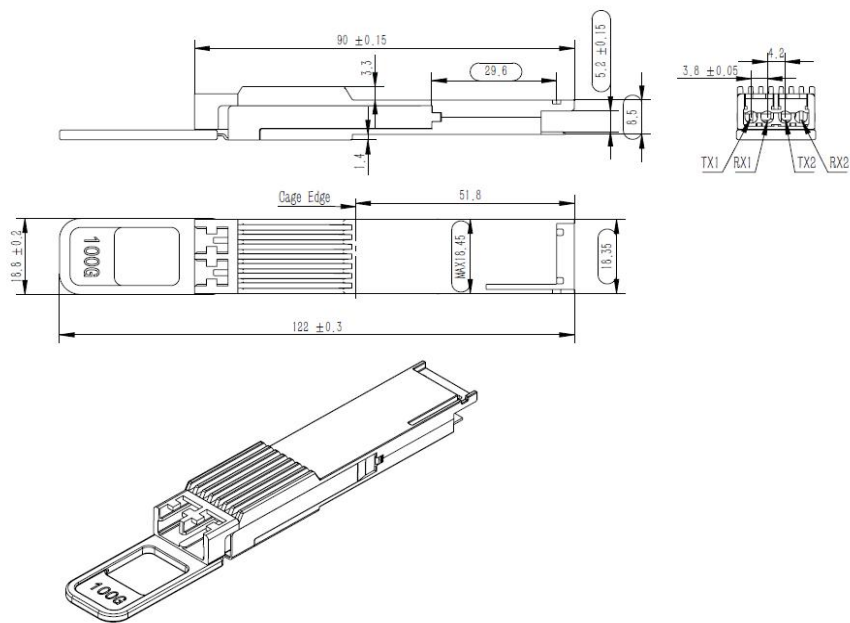

Wavelength Table

TX1			TX2		
Ch. No.	Frequency (THz)	Center Wavelength(nm)	Ch. No.	Frequency (THz)	Center Wavelength(nm)
C13	191.30	1567.13	C14	191.40	1566.31
C13+	191.35	1566.72	C14+	191.45	1565.90
C15	191.50	1565.50	C16	191.60	1564.68
C15+	191.55	1565.09	C16+	191.65	1564.27
C17	191.70	1563.86	C18	191.80	1563.05
C17+	191.75	1563.45	C18+	191.85	1562.64
C19	191.90	1562.23	C20	192.00	1561.42
C19+	191.95	1561.83	C20+	192.05	1561.01
C21	192.10	1560.61	C22	192.20	1559.79

C21+	192.15	1560.20	C22+	192.25	1559.39
C23	192.30	1558.98	C24	192.40	1558.17
C23+	192.35	1558.58	C24+	192.45	1557.77
C25	192.50	1557.36	C26	192.60	1556.55
C25+	192.55	1556.96	C26+	192.65	1556.15
C27	192.70	1555.75	C28	192.80	1554.94
C27+	192.75	1555.34	C28+	192.85	1554.54
C29	192.90	1554.13	C30	193.00	1553.33
C29+	192.95	1553.73	C30+	193.05	1552.93
C31	193.10	1552.52	C32	193.20	1551.72
C31+	193.15	1552.12	C32+	193.25	1551.32
C33	193.30	1550.92	C34	193.40	1550.12
C33+	193.35	1550.52	C34+	193.45	1549.72
C35	193.50	1549.32	C36	193.60	1548.51
C35+	193.55	1548.91	C36+	193.65	1548.11
C37	193.70	1547.72	C38	193.80	1546.92
C37+	193.75	1547.32	C38+	193.85	1546.52
C39	193.90	1546.12	C40	194.00	1545.32
C39+	193.95	1545.72	C40+	194.05	1544.92
C41	194.10	1544.53	C42	194.20	1543.73
C41+	194.15	1544.13	C42+	194.25	1543.33
C43	194.30	1542.94	C44	194.40	1542.14
C43+	194.35	1542.54	C44+	194.45	1541.75
C45	194.50	1541.35	C46	194.60	1540.56
C45+	194.55	1540.95	C46+	194.65	1540.16
C47	194.70	1539.77	C48	194.80	1538.98
C47+	194.75	1539.37	C48+	194.85	1538.58
C49	194.90	1538.19	C50	195.00	1537.40
C49+	194.95	1537.79	C50+	195.05	1537.00
C51	195.10	1536.61	C52	195.20	1535.82
C51+	195.15	1536.22	C52+	195.25	1535.43
C53	195.30	1535.04	C54	195.40	1534.25
C53+	195.35	1534.64	C54+	195.45	1533.86
C55	195.50	1533.47	C56	195.60	1532.68
C55+	195.55	1533.07	C56+	195.65	1532.29
C57	195.70	1531.90	C58	195.80	1531.12
C57+	195.75	1531.51	C58+	195.85	1530.72
C59	195.90	1530.33	C60	196.00	1529.55
C59+	195.95	1529.94	C60+	196.05	1529.16

Notes:

The two channels of the transceiver meet above wavelength table. And other channel wavelength configurations are acceptable for customize design.

All the specification is designed by single wavelength.

